

# Relais Statique Triphasé Three Phase Solid State Relays

## SWT862090

24 to 520 VAC - 3 x 32 ARMS  
11000A<sup>2</sup> s

- Relais synchrone sortie AC Prêt à l'emploi
- Commande 90-240VAC . LED.
- Protection interne par RC et écrêteur de tension .
- IP20
- Zero cross AC output. For all types of loads
- 90-240VAC control voltage with LED
- Internal protection by and clamping voltage.
- IP20

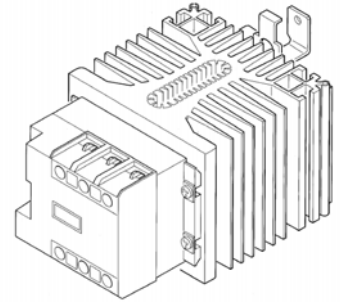

**Dimensions / Dimensions:**

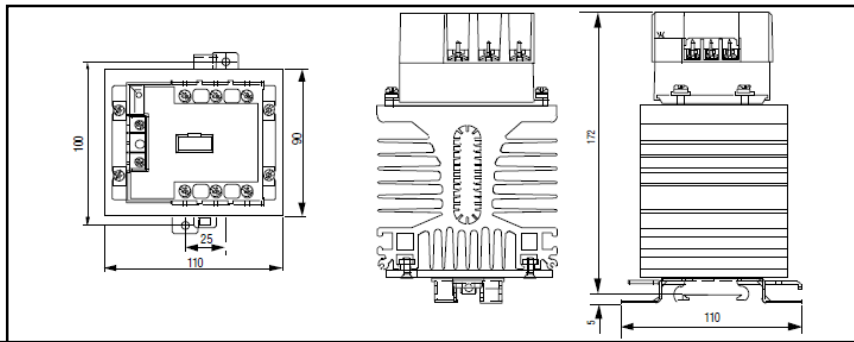

**Circuit équivalent/Equivalent circuit :**

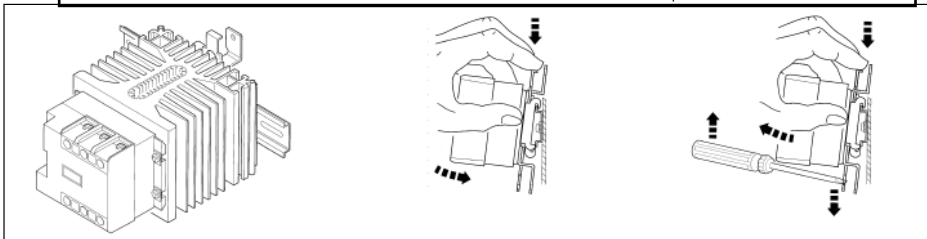
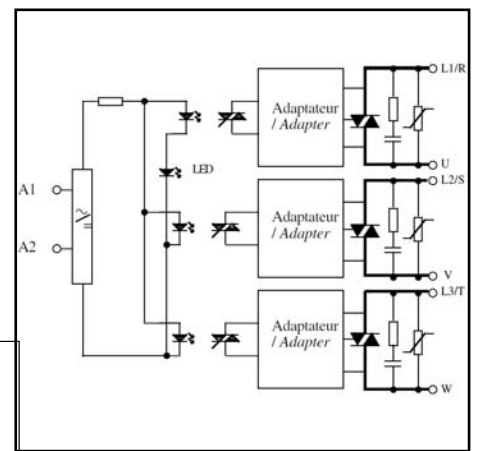

**Caractéristiques de commande (à 20°C) / Control characteristics (at 20°C)**

Paramètre / Parameter	Symbol	AC-DC			Unit
		Min	Nom	Max	
Tension de commande / Control voltage : DC	Uc	90		240	VDC
Tension de commande / Control voltage : AC	Uc	90		240	VAC
Courant de commande / Control current (@ Uc)	Ic	4,5		11	mA
Tension de relachement/Release voltage	Uc off	15			V
Résistance interne / Input internal resistor fig.1	Rc		21		KΩ
Tension inverse / Reverse voltage	Urv	polarity free			V

fig. 1 :Caractéristique d'entrée / Control characteristic

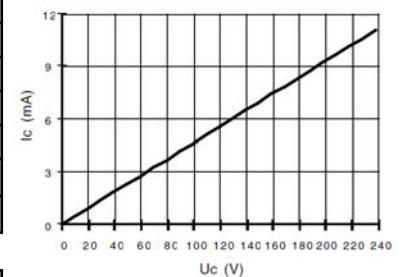

**Caractéristiques d'entrée-sortie (à 20°C) / Input-output characteristics (at 20°C)**

Isolement entrée-sortie/Input-output isolation @500m	Ui		4000		VRMS
Isolement sortie-semelle/Output-case isolation @500m	Ui		3300		VRMS
Tension assignée isolement/ Rated impulse voltage	Uimp		4000		V

**Caractéristiques générales / General characteristics**

Paramètre / Parameter	Conditions	Symbol	Typ.	Unit
Poids/Weight			1900	g
Plage de température de stockage / Storage temperature range			-40 / +100	°C
Plage de température de fonctionnement/Operating temperature range			-40 / +100	°C

Proud to serve you

All technical characteristics are subject to change without previous notice.  
Caractéristiques sujettes à modifications sans préavis.

## Caractéristiques de sortie (à 20°C) / Output characteristics (at 20°C)

Paramètre / Parameter	Conditions	Symbol	Typ.	Unit
Tension de charge / Load voltage		Ue	400	V rms
Plage tension de fonctionnement / Operating range	( 480Vrms + 10% )	Uemax	530	V rms
Tension crête / Peak voltage		Up	1200	V
Niveau de synchronisation / Synchronizing level		U <sub>sync</sub>	12	V
Tension d'amorçage / Latching voltage	Ie nom	Ua	10	V
Courant nominal AC-51 non permanent/ AC-51 no permanent nominal current	( see Fig. 2 )	Ie AC-51	95	A rms
Courant nominal AC-51/ AC-51 nominal current @25°C	( see Fig. 2 )	Ie AC-51	3x32	A rms
Courant nominal AC-53/ AC-53 nominal current	( see Fig. 2 )	Ie AC-53	24	A rms
Puissance max (moteur triphasé) Max 3 pole motor power (400 VAC)		Pn	11	kW
Puissance max (moteur triphasé) 3 pole motor power(400VAC)/EN60947-2		Pn	7,5	kW
Courant de surcharge non répétitif / Non repetitive overload current	tp=10ms (Fig. 3)	I <sub>tsm</sub>	1500	A
Chute tension directe crête/ On state voltage drop	@ Ie nom	Vd	1,4	V
Courant de fuite état bloqué/ Off state leakage current	@Ue, 50Hz	I <sub>lk</sub>	2,5	mA
Courant de charge minimum / Minimum load current		Ie min	5	mA
Temps de fermeture/ Turn on time	Uc nom DC ,f=50Hz	ton max	30	ms
Temps d'ouverture/ Turn off time	Uc nom DC ,f=50Hz	toff max	30	ms
Plage de fréquence / Operating frequency range		f	10-400	Hz
dv/dt état bloqué / Off state dv/dt		dv/dt	500	V/μs
dI/dt maximum non répétitif/ Maximum di/dt non repetitive		di/dt	50	A/μs
I <sup>2</sup> t (<10ms)		I <sup>2</sup> t	11000	A <sup>2</sup> s
EMC Test d'immunité conduite / Conducted immunity level	IEC 1000-4-4 (burst)	4kV criterion A		
EMC Test d'immunité conduite / Conducted immunity level	IEC 1000-4-5(schocks)	2kV crit.A		
Conformité / Conformity	EN60947-4-x			

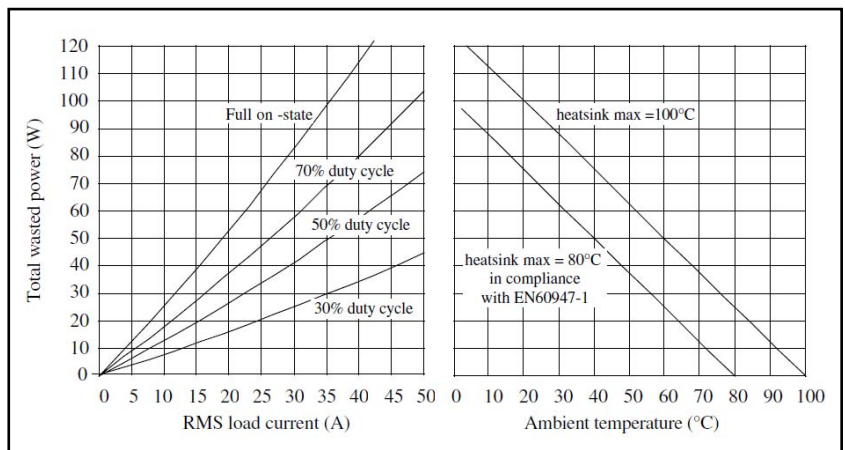
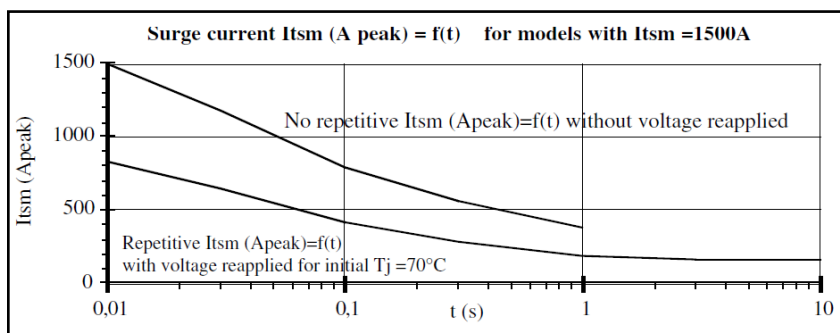
**Caractéristiques thermiques/  
thermal curves :**Fig.3 Courbes de surcharge de courant /  
Overload current curves

- 1 -I<sub>tsm</sub> non répétitif sans tension réappliquée est donné pour la détermination des protections.  
*No repetitive I<sub>tsm</sub> is given without voltage reapplied for the determination of the protection.*
- 2 -I<sub>tsm</sub> répétitif est donné pour des surcharges de courant (T<sub>j</sub> initiale=70°C). La répétition de ces surcharges de courant diminue la durée de vie du Relais.  
*Repetitive I<sub>tsm</sub> is given for inrush current with initial T<sub>j</sub> = 70°C. The repetition of the surge current decrease the lifetime SSR's.*

**Précautions :**

\* Les relais à semiconducteurs ne procurent pas d'isolation galvanique entre le réseau et la charge.

**Cautions :**

\* Semiconductor relays don't provide any galvanic insulation between the load and the mains.



5, Rue Ampère BP30004  
relais@celduc.com

Fax +33 (0) 4 77 53 85 51





**celduc**<sup>®</sup>  
r e l a i s





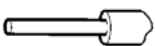

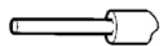
42290 SORBIERS - FRANCE

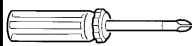
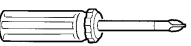
E-mail : celduc-

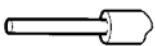
Service Commercial France Tél. : +33 (0) 4 77 53 90 20

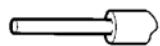
www.celduc.com

SVT <b>Cablage commande / Wiring of the control circuit:</b>						
nombre de fils/ NUMBER OF WIRES				SCREWDRIVER TYPE		MINIMUM TORQUE couple serrage
1		2		tournevis	tournevis	
SOLID (No ferrule) rigide sans embout	FINE STRANDED (With ferrule) multibrins avec embouts	SOLID (No ferrule) rigide sans embout	FINE STRANDED (With ferrule) multibrins avec embouts			
						N.m
0,75 ... 2,5 mm <sup>2</sup>	0,75 ... 2,5 mm <sup>2</sup>	0,75 ... 2,5 mm <sup>2</sup>	0,75 ... 2,5 mm <sup>2</sup>	0,8 x 5,5 mm	POZIDRIV 2	1,2

SVT <b>Cablage puissance / Wiring of the power circuit:</b>						
NUMBER OF WIRES				SCREWDRIVER TYPE		MINIMUM TORQUE couple serrage
1		2		tournevis	tournevis	
SOLID (No ferrule) rigide sans embout	FINE STRANDED (With ferrule) multibrins avec embouts	SOLID (No ferrule) rigide sans embout	FINE STRANDED (With ferrule) multibrins avec embouts			
						N.m
1,5 ... 10 mm <sup>2</sup>	1,5 ... 6 mm <sup>2</sup>	1,5 ... 10 mm <sup>2</sup>	1,5 ... 6 mm <sup>2</sup>	0,8 x 5,5 mm	POZIDRIV 2	1,8

